



the Three

Klipsch[®]
HERITAGE
WIRELESS

TABLE OF CONTENTS

- 1 - INSIDE
- 2 - CONTROLS
- 3-4 - REMOTE CONTROL
- 5 - POWER SWITCH
- 6 - SOURCE CONTROL DIAL
- 7 - BLUETOOTH® WIRELESS TECHNOLOGY
- 8-9 - CONNECTIONS - WIFI NETWORK
- 10-12 - DTS - PLAY-FI WIRELESS STREAMING TECHNOLOGY
- 13 - SPOTIFY CONNECT
- 14 - CONNECTIONS - 3.5MM AUXILIARY - INPUT
- 15 - CONNECTIONS - ANALOG RCA - INPUT
- 16 - CONNECTIONS - TURNTABLE - INPUT
- 17 - CONNECTIONS - USB AUDIO - INPUT
- 18 - FACTORY RESET
- 18 - CARE & CLEANING

INSIDE

CONTENU • CONTENIDO • INHALT • CONTENUTO • CONT EÚDO • 目录

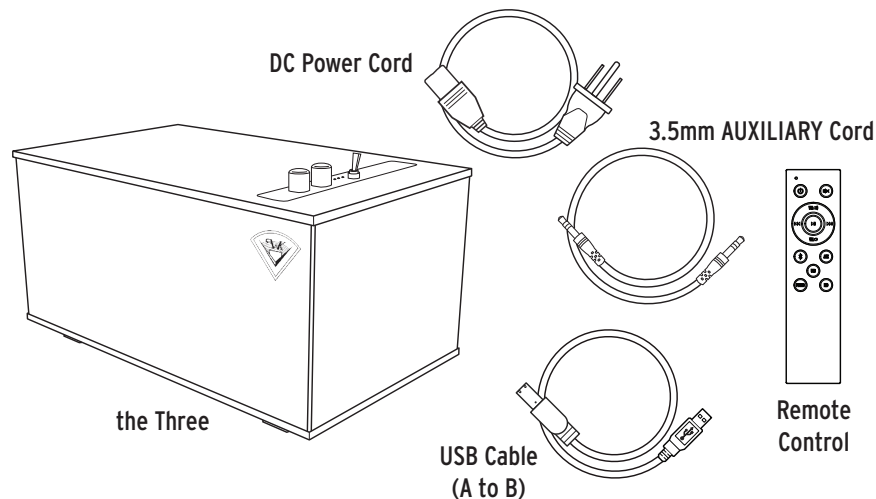

<p>DC Power Cord Cordon d'alimentation c.c. Cordon de alimentación de CC Gleichstromkabel Cavo di alimentazione CC Cabo de alimentação de CC 直流电源线</p>	<p>3.5mm AUXILIARY AUXILIAIRE 3,5mm 3.5 mm AUXILIAR 3,5-mm-AUX INGRESSO AUSILIARIO DA 3,5 mm AUXILIAR DE 3,5 MM 3.5mm 辅助电缆)</p>	<p>USB Cable Câble USB Cable USB USB-Kabel Cavo USB Cabo USB USB 电缆</p>	<p>Remote Control Télécommande Control remoto Fernbedienung Telecomando Controle remoto 遥控器</p>
---	--	--	--

CONTROLS

CONTRÔLES • CONTROLES • STEUERUNG • CONTROLLI • CONTROLES • 控制

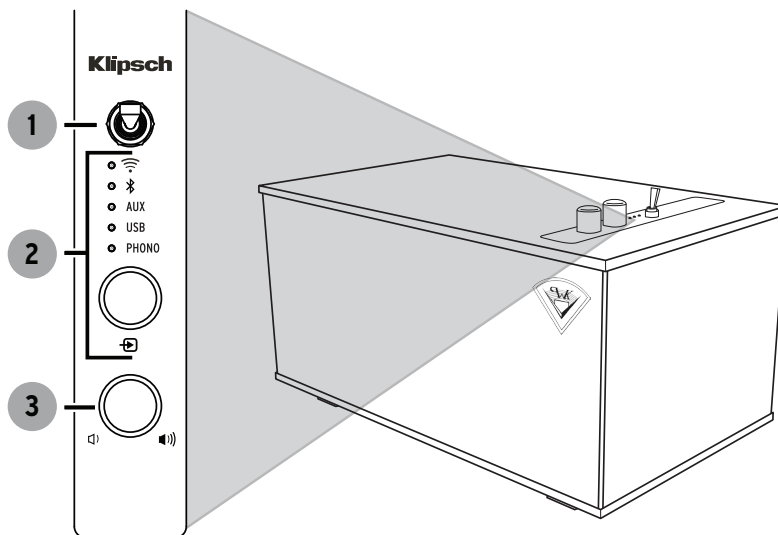

<p>1 Power Switch Interrupteur d'alimentation Interruptor de alimentación Netzschalter Interruttore generale Chave liga/desliga 电源开关</p>	<p>2 Source Source Fuente Quelle Sorgente Fonte 輸入源的切换</p>	<p>3 Volume Dial Bouton de volume Dial de volumen Lautstärkereglern Comando volume Botão de volume 音量控制</p>
--	--	---

REMOTE CONTROL

TÉLÉCOMMANDE • CONTROL REMOTO • FERNBEDIENUNG • TELECOMANDO • CONTROLE REMOTO • 遙控器

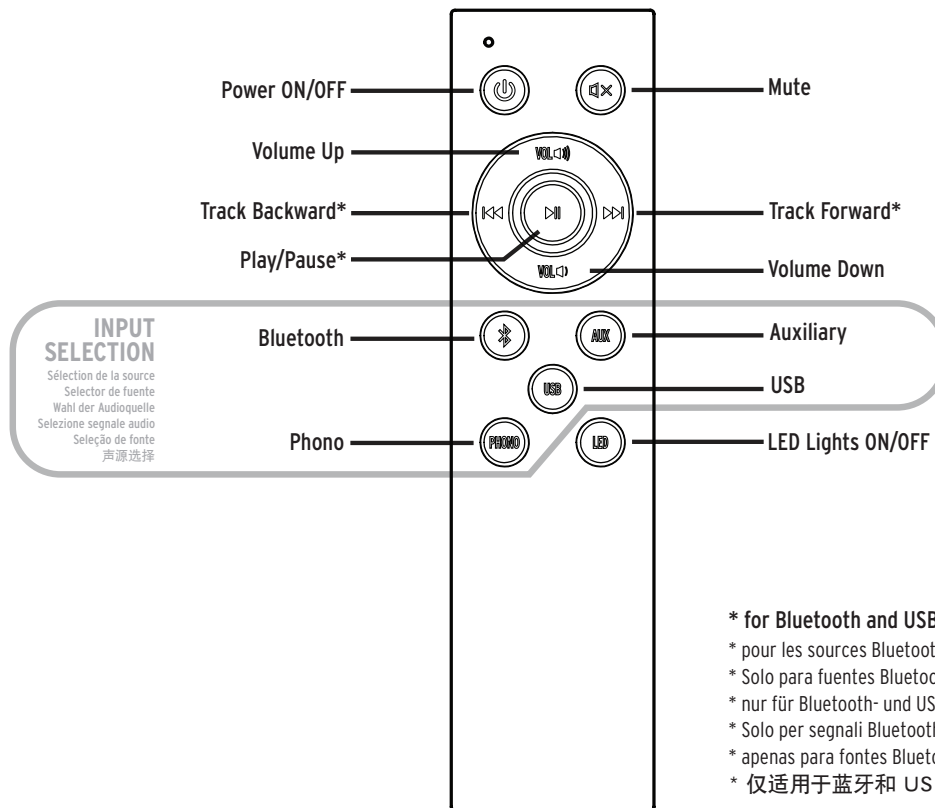

REMOTE CONTROL

TÉLÉCOMMANDE • CONTROL REMOTO • FERNBEDIENUNG • TELECOMANDO • CONTROLE REMOTO • 遥控器

<p>Power ON/OFF Sous tension / Hors tension Encendido / Apagado Ein / Aus Acceso / Spento Ligar / Desligar 开/关</p>	<p>Volume Up Volume haut Subida de volumen Lauter Aumento volume Aumentar o volume 音量增大</p>	<p>Track Backward Reculer Retroceso de pista Voriger Titel Brano precedente Retrocede 快退</p>	<p>Play/Pause Lecture/pause Reproducción/pausa Wiedergabe/Pause Riproduzione / Pausa Reproduzir/Pausar 播放/暂停</p>
<p>Bluetooth Bluetooth Bluetooth Bluetooth Bluetooth 蓝牙</p>	<p>Phono Phono Tocadiscos Phono Fono Fono 模拟音频输入接口</p>	<p>Mute Sourdine Silenciador Stummschaltung Disattivazione audio Desativar áudio 静音</p>	<p>Track Forward Avancer Avance de pista Nächster Titel Brano successivo Avançar 快进</p>
<p>Volume Down Volume bas Bajada de volumen Leiser Riduzione volume Diminuir o volume 音量减小</p>	<p>Auxiliary Auxiliaire Auxiliar AUX-Eingang Ausiliario Auxiliar 辅助输入接口</p>	<p>USB USB USB USB USB USB USB</p>	<p>LED Lights ON/OFF Voyants DEL MARCHE/ARRÊT ACTIVACIÓN / DESACTIVACIÓN DE indicadores LED LEDs AN/AUS Spie LED ACCESE/SPENTE ACENDER/APAGAR LEDs LED 灯开/关</p>

POWER SWITCH

INTERRUPTEUR D'ALIMENTATION • INTERRUPTOR DE ALIMENTACIÓN • NETZSCHALTER • INTERRUPTORE GENERALE • CHAVE LIGA/DESLIGA • 电源开关

POWER ON / STANDBY

MISE SOUS TENSION / VEILLE
ENCENDIDO / EN ESPERA
EIN / STANDBY
ACCESO / STANDBY
LIGADO / ESPERA
接通电源 / 待机

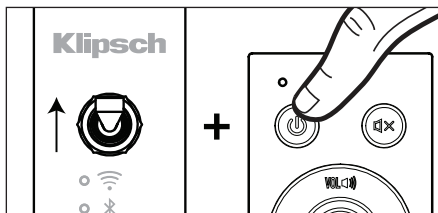

PRESS ONCE TO POWER ON

APPUYER UNE FOIS POUR METTRE SOUS TENSION
OPRIMIR UNA VEZ PARA ENCENDER
ZUM EINSCHALTEN EINMAL DRÜCKEN
PREMERE UNA VOLTA PER ACCENDERE
PRESSIONE UMA VEZ PARA LIGAR
按一下接通电源

PRESS AGAIN TO ENTER STANDBY MODE

APPUYER À NOUVEAU POUR PASSER EN MODE VEILLE
OPRIMIR OTRA VEZ PARA ENTRAR A MODALIDAD EN ESPERA
FÜR STANDBY-MODUS ERNEUT DRÜCKEN
PREMERE DI NUOVO PER SELEZIONARE LA MODALITÀ DI STANDBY
PRESSIONE NOVAMENTE PARA INICIAR O MODO DE ESPERA
再按一下进入待机模式

POWER OFF

MISE HORS TENSION
APAGADO
AUS
SPENTO
DESLIGADO
关闭电源

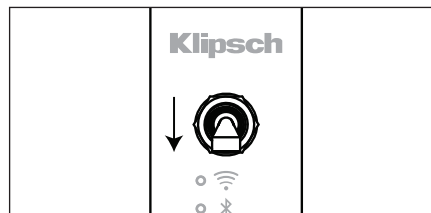

SOURCE CONTROL DIAL

BOUTON DE COMMANDE DE LA SOURCE • DIAL DE CONTROL DE FUENTE • QUELLENWAHL-REGLER • COMANDO SEGNALE • BOTÃO DE CONTROLE DA FONTE • 源控制盘

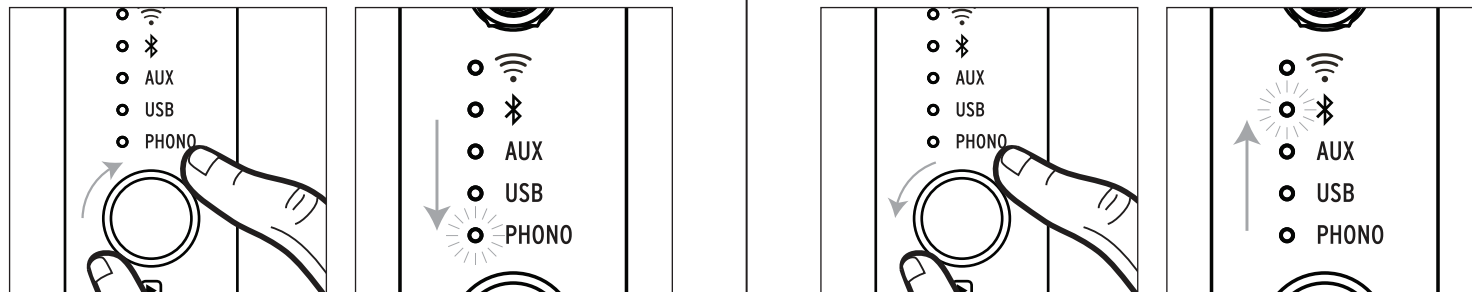

WIFI SOURCE SELECTION ONLY AVAILABLE ONCE PLAY-FI NETWORK CONNECTION IS ESTABLISHED

LA SELECTION DE LA SOURCE WIFI EST DISPONIBLE SEULEMENT UNE FOIS LA CONNEXION AU RESEAU PLAY-FI ETABLIE
SELECCIÓN DE WI-FI SOLO DESPUÉS DE CONECTAR A RED PLAY-FI
WLAN-QUELLENWAHL ERST MÖGLICH, SOBALD PLAYFI-NETZWERKVERBINDUNG HERGESTELLT IST
SELEZIONE DEL SEGNALE WIFI DISPONIBILE SOLO DOPO CHE È STATA STABILITA LA CONNESSIONE CON LA RETE PLAY-FI
SELEÇÃO DA FONTE DE WIFI DISPONÍVEL SOMENTE DEPOIS DE A CONEXÃO DE REDE PLAY-FI SER ESTABELECIDADA
仅当PLAY-FI 网络连接建立时可进行WIFI 源选择

BLUETOOTH® WIRELESS TECHNOLOGY

TECNOLOGÍA INALÁMBRICA **BLUETOOTH®** • CONFIGURACIÓN DE TECNOLOGÍA WIRELESS **BLUETOOTH®** • DRAHTLOSE **BLUETOOTH®**-TECHNOLOGIE-SETUP • CONFIGURAZIONE TECNOLOGIA WIRELESS **BLUETOOTH®** • CONFIGURAÇÃO DE TECNOLOGIA SEM FIO **BLUETOOTH®** • **BLUETOOTH®** 蓝牙无线技术

PAIR

CONNEXION
CONEXIÓN
VERBINDEN
COLLEGAMENTO
CONECTAR
连接

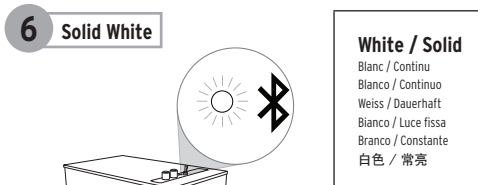
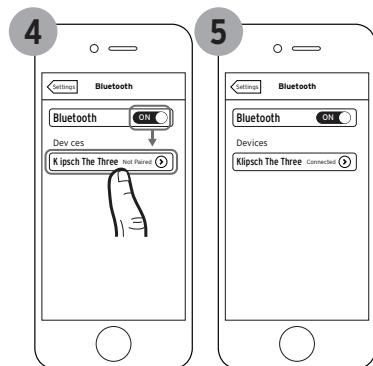
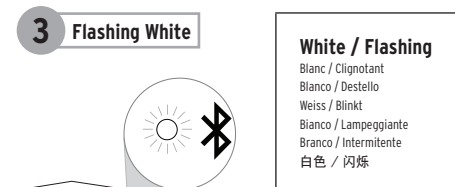
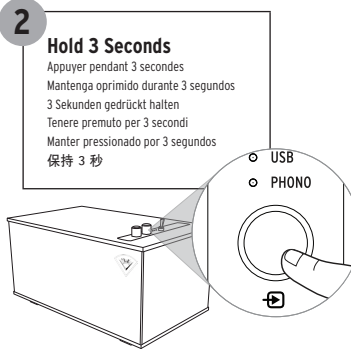
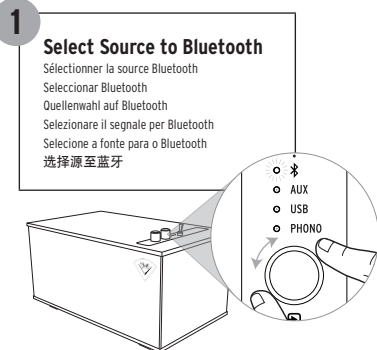

Example only. Your device may differ.

• À titre d'exemple seulement. Votre appareil peut être différent. • Este es solo un ejemplo. Es posible que su dispositivo sea diferente. • Nur als Beispiel. Ihr Gerät kann anders aussehen
• Solo a titolo esemplificativo. Lo specifico dispositivo può essere diverso. • Apenas para exemplo. O dispositivo pode ser diferente. • 仅为示例。实际设备可能有所不同

CONNECTIONS - WIFI NETWORK (NOTE: PLAY-FI REQUIRES USE OF AN 802.11N WIRELESS ROUTER OR BETTER)

CONNEXIONS - RÉSEAU WI-FI (REMARQUE : PLAY-FI NÉCESSITE L'UTILISATION D'UN ROUTEUR SANS FIL 802.11N OU MIEUX) • CONEXIONES - RED WI-FI (NOTA: PLAY-FI REQUIERE UN ROUTER INALÁMBRICO 802.11N O MÁS RECIENTE) • ANSCHLÜSSE - WLAN (HINWEIS: PLAY-FI ERFORBERT DIE VERWENDUNG EINES WLAN-ROUTERS NACH DER NORM 802.11N ODER BESSER) • CONNESSIONI - RETE WI-FI (NOTA: PLAY-FI RICHIEDE L'USO DI UN ROUTER WIRELESS 802.11N O SUPERIORE) • CONEXÕES - REDE WIFI (OBSERVAÇÃO: O PLAY-FI REQUER O USO DE UM ROTEADOR SEM FIO 802.11N OU MELHOR) • 连接 - WIFI 网络 备注 : PLAY-FI 需要使用 802.11N 或性能更佳的路由器

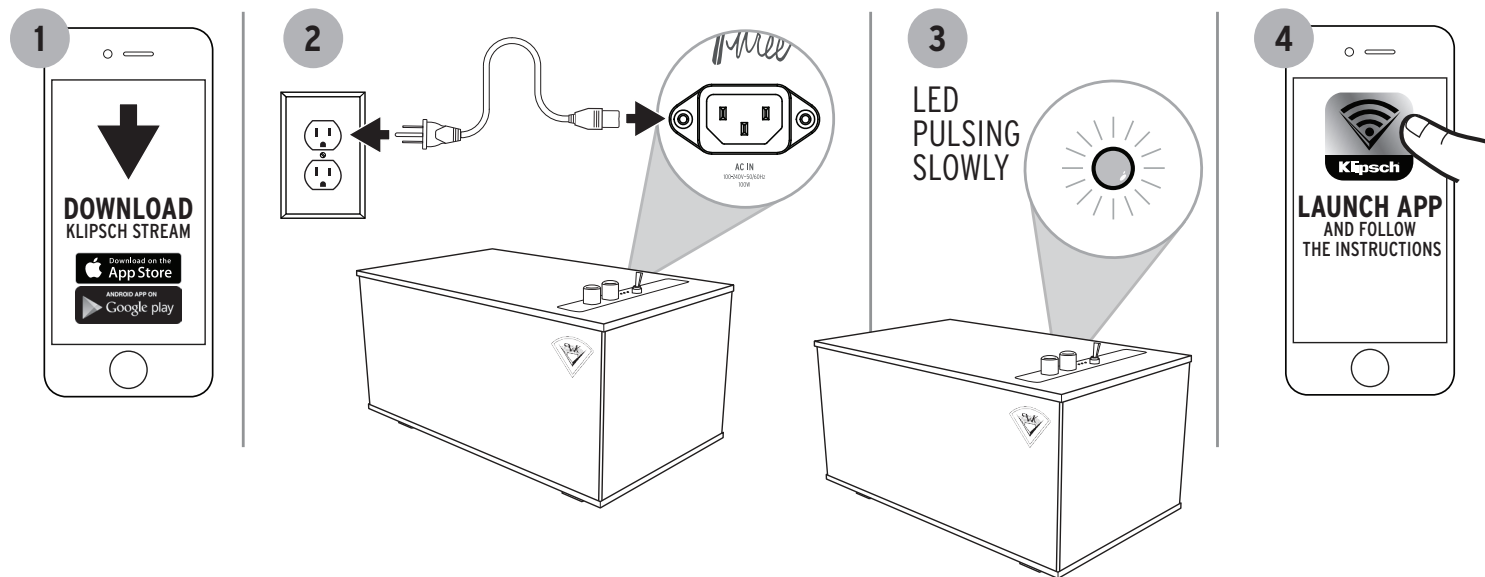

CONNECTIONS - WIFI NETWORK (NOTE: PLAY-FI REQUIRES USE OF AN 802.11N WIRELESS ROUTER OR BETTER)

CONNEXIONS - RÉSEAU WI-FI (REMARQUE : PLAY-FI NÉCESSITE L'UTILISATION D'UN ROUTEUR SANS FIL 802.11N OU MIEUX) • CONEXIONES - RED WI-FI (NOTA: PLAY-FI REQUIERE UN ROUTER INALÁMBRICO 802.11N O MÁS RECIENTE) • ANSCHLÜSSE - WLAN (HINWEIS: PLAY-FI ERFORDERT DIE VERWENDUNG EINES WLAN-ROUTERS NACH DER NORM 802.11N ODER BESSER) • CONNESSIONI - RETE WI-FI (NOTA: PLAY-FI RICHIEDE L'USO DI UN ROUTER WIRELESS 802.11N O SUPERIORE) • CONEXÕES - REDE WIFI (OBSERVAÇÃO: O PLAY-FI REQUER O USO DE UM ROTEADOR SEM FIO 802.11N OU MELHOR) • 连接 - WIFI 网络 备注 : PLAY-FI 需要使用 802.11N 或性能更佳 的无线路由器

IF

LED IS NOT PULSING

SI L'ICÔNE NE CLIGNOTE PAS
SI EL ICONO NO ESTÁ OSCILANDO
WENN SYMBOL NICHT BLINKT
SE L'ICONA NON LAMPEGGIA
SE O ÍCONE NÃO ESTIVER
PULSANDO
如果图标未脉动

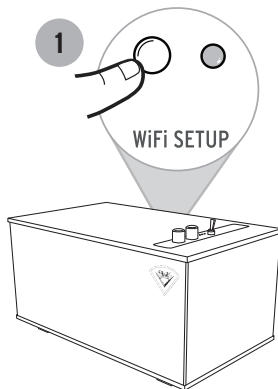

HOLD 10 SECONDS

MAINTENEZ ENFONCÉ PENDANT 10 SECONDES
MANTENGA OPRIMIDO 10 SEGUNDOS
10 SEKUNDEN GEDRÜCKT HALTEN
TENERE PREMUTO PER 10 SECONDI
MANTER PRESS ONADO POR 10 SEGUNDOS
按住 10 秒

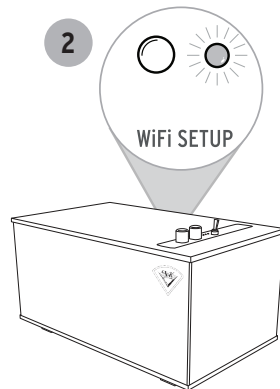

LED
PULSING
SLOWLY

IF

YOU HAVE A WPS ROUTER

SI VOUS AVEZ UN ROUTEUR WPS
SI TIENE UN ROUTER WPS
WENN SIE EINEN WPS-ROUTER HABEN
SE SI USA UN ROUTER WPS
SE O ROTEADOR FOR WPS
如果您拥有 WPS 路由器

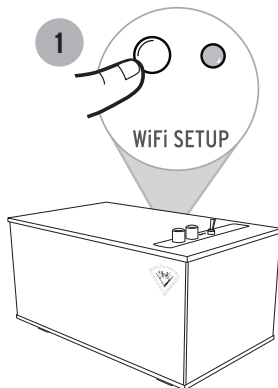

HOLD 4 SECONDS

MAINTENEZ ENFONCÉ PENDANT 4 SECONDES
MANTENGA OPRIMIDO 4 SEGUNDOS
4 SEKUNDEN GEDRÜCKT HALTEN
TENERE PREMUTO PER 4 SECONDI
MANTER PRESSIONADO POR 4 SEGUNDOS
按住 4 秒

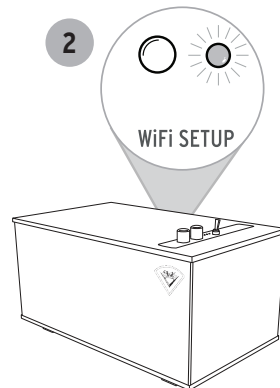

LED
PULSING
SLOWLY

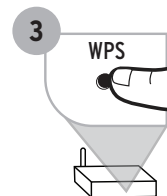

DTS PLAY-FI WIRELESS STREAMING TECHNOLOGY

TECNOLOGIE DE DIFFUSION SANS FIL DTS PLAY-FI • TECNOLOGÍA DE STREAMING INALÁMBRICO PLAY-FI DE DTS • DTS PLAY-FI DRAHTLOSE STREAMING-TECHNOLOGIE • TECNOLOGIA STREAMING WIRELESS DTS PLAY-FI • TECNOLOGIA DE STREAMING SEM TECNOLOGIA DE STREAMING SEM FIO DTS PLAY-FI FIO DTS PLAY-FI • DTS PLAY-FI 无线串流技术

NETWORK AND SYSTEM REQUIREMENTS

- WiFi Router 802.11n or better
- iOS device with version 6.0 operating system or newer **OR** Android Smartphone/tablet with version 2.2 operating system or newer
- The password to your home WiFi network (if you have a WPS-enabled router, you don't need this)

CONFIGRATIONS DE SYSTEME ET DE RESEAU REQUISES

- Router WiFi 802.11n ou meilleur
- appareil iOS avec système d'exploitation de version 6.0 ou plus récente **OU** Smartphone/tablette Android avec système d'exploitation de version 2.2 ou plus récente
- Le mot de passe du réseau Wi-Fi de votre domicile (si vous avez un routeur compatible WPS, vous n'en avez pas besoin)

REQUISITOS DE RED Y SISTEMA

- Router WiFi 802.11n o más reciente
- Dispositivo iOS con sistema de operación versión 6.0 o más reciente **O BIEN** Teléfono inteligente o tableta Android con sistema de operación versión 2.2 o más reciente
- La contraseña de la red Wi-Fi de su casa (si tiene un router WPS, no necesita esto)

NETZWERK- UND SYSTEMANFORDERUNGEN

- WLAN-Router 802.11n oder besser
- iOS-Gerät mit Betriebssystem 6.0 oder neuer **ODER** Android-Smartphone/ Tablet mit Betriebssystem 2.2 oder neuer
- Das Passwort für Ihr WLAN (wenn Sie einen WPS-fähigen Router haben, benötigen Sie das nicht)

REQUISITI DI RETE E DI SISTEMA

- Router Wi-Fi 802.11n o superiore
- Dispositivo iOS con sistema operativo versione 6.0 o successiva **OPPURE** Smartphone/ tablet Android con sistema operativo versione 2.2 o successiva
- La password della rete Wi-Fi domestica (non necessaria se si usa un router compatibile con WPS)

REQUISITOS DE SISTEMA E REDE

- Roteador WiFi 802.11n ou melhor
- Dispositivo iOS com a versão 6.0 do sistema operacional ou mais recente **OU** Smartphone/tablet Android com a versão 2.2 do sistema operacional ou mais recente • A senha da rede WiFi doméstica (se o roteador for habilitado para WPS, não é necessária)

网络和系统要求

- WiFi 路由器 802.11n 或更佳性能
- 带有 6.0 或更新版本操作系统的 iOS 装置 或带有 2.2 或更新版本操作系统的 Android 智能手机/平板电脑
- 您家里 WiFi 网络的密码 (如果您拥有支持 WPS 的路由器, 则不需要此密码)

DTS PLAY-FI WIRELESS STREAMING TECHNOLOGY

TECNOLOGIE DE DIFFUSION SANS FIL DTS PLAY-FI • TECNOLOGÍA DE STREAMING INALÁMBRICO PLAY-FI DE DTS • DTS PLAY-FI DRAHTLOSE STREAMING-TECHNOLOGIE • TECNOLOGIA STREAMING WIRELESS DTS PLAY-FI • TECNOLOGIA DE STREAMING SEM FIO DTS PLAY-FI FIO DTS PLAY-FI • DTS PLAY-FI 无线串流技术

CONNECT TO YOUR WIFI NETWORK

The Three features DTS Play-Fi wireless multi-room streaming technology. Download the Klipsch Stream app, and listen to music from your personal library, internet streaming services like Tidal®, Pandora®, Spotify®, Amazon Prime Music®, iHeart Radio®, Sirius XM Radio, Deezer®, and independent internet radio stations like Disney, BBC, NPR, etc.

SE CONNECTER AU RÉSEAU Wi-Fi

Le Three est doté de la technologie de diffusion multi-pièce sans fil DTS Play-Fi. Téléchargez l'application Klipsch Stream et écoutez de la musique à partir de votre bibliothèque personnelle, des services de diffusion en ligne tels que Tidal®, Pandora®, Spotify®, Amazon Prime Music®, iHeart Radio®, Sirius XM Radio, Deezer®, et des stations de radio en ligne indépendantes telles que Disney, BBC, NPR, etc.

CONECTE A SU RED DE Wi-Fi

El altavoz Three tiene tecnología de streaming inalámbrico multihabitación Play-Fi de DTS. Descargue la aplicación Klipsch Stream y escuche música de su biblioteca personal; sus servicios de streaming por Internet, tales como Tidal®, Pandora®, Spotify®, Amazon Prime Music®, iHeart Radio®, Sirius XM Radio, Deezer®, y sus emisoras de radio por Internet independientes, tales como Disney, BBC, NPR, etc.

VERBINDEN SIE IHR WLAN

Das Three -System bietet die drahtlose Streaming-Technologie DTS Play-Fi für mehrere Räume. Laden Sie die App Klipsch Stream herunter und hören Sie Musik aus Ihrer persönlichen Bibliothek oder über Internet-Streaming-Dienste wie Tidal®, Pandora®, Spotify®, Amazon Prime Music®, iHeart Radio®, Sirius XM Radio, Deezer® und unabhängige Internet-Radiosender wie Disney, BBC, NPR, usw.

COLLEGAMENTO ALLA RETE WI-FI

Il Three presenta la tecnologia streaming multi-sala wireless DTS Play-Fi. Scarica l'app Klipsch Stream e ascolta musica dalla tua collezione personale, da servizi di streaming Internet come Tidal®, Pandora®, Spotify®, Amazon Prime Music®, iHeart Radio®, Sirius XM Radio, Deezer® e da stazioni radio Internet indipendenti come Disney, BBC, NPR, ecc.

CONEXÃO À REDE WIFI

A Three tem tecnologia de streaming multi-ambientes sem fio DTS Play-Fi. Baixe o aplicativo Klipsch Stream e ouça músicas de sua biblioteca pessoal, serviços de streaming da internet, como Tidal®, Pandora®, Spotify®, Amazon Prime Music®, iHeart Radio®, Sirius XM Radio, Deezer®, e estações de rádio na internet independentes, como Disney, BBC, NPR, etc.

连接至您的WIFI网络

Three 采用了 DTS Play-Fi 无线多房间串流技术。下载 Klipsch 串流应用程序，聆听源自您的个人音乐库，诸如 Tidal®、Pandora®、Spotify®、Amazon Prime Music®、iHeart Radio®、Sirius XM Radio、Deezer® 之类互联网串流服务以及类似 Disney、BBC、NPR 等独立互联网无线电台的音乐。

DTS PLAY-FI WIRELESS STREAMING TECHNOLOGY

TECNOLOGIE DE DIFFUSION SANS FIL DTS PLAY-FI • TECNOLOGÍA DE STREAMING INALÁMBRICO PLAY-FI DE DTS • DTS PLAY-FI DRAHTLOSE STREAMING-TECHNOLOGIE • TECNOLOGIA STREAMING WIRELESS DTS PLAY-FI • TECNOLOGIA DE STREAMING SEM FIO DTS PLAY-FI FIO DTS PLAY-FI • DTS PLAY-FI 无线串流技术

ADD OTHER KLIPSCH STREAM WIRELESS MULTI-ROOM PRODUCTS	AJOUTER D'AUTRES PRODUITS MULTI-PIÈCES SANS FIL KLIPSCH STREAM	AGREGUE PRODUCTOS DE STREAMING INALÁMBRICO MULTIHABITACIÓN DE KLIPSCH	FÜGEN SIE WEITERE KLIPSCH STREAM DRAHTLOSE MEHRZIMMER-PRODUKTE HINZU	AGGIUNGI ULTERIORI PRODOTTI WIRELESS MULTI-SALA IN STREAMING KLIPSCH	ADIÇÃO DE OUTROS PRODUTOS DE STREAMING SEM FIO MULTIAMBIENTES DA KLIPSH	添加其它杰士 Klipsch 串流无线多房间产品
From the Klipsch Stream app:	Dans l'application Klipsch Stream :	En la aplicación Klipsch Stream:	Gehen Sie in der App Klipsch Stream folgendermaßen vor:	Dall'app Klipsch Stream:	No aplicativo Klipsch Stream:	添加其他 Klipsch 无线多房间串流扬声器 :
1. Choose "Settings"	1. Choisir « Settings » (Réglages)	1. Escoja "Settings" (Configuraciones)	1. Wählen Sie „Settings“ (Einstellungen)	1. Scegliere "Settings" (Impostazioni).	1. Escolha "Settings" (Configurações).	1. 选择“设置”
2. Add "DTS Play-Fi Device"	2. Ajouter « DTS Play-Fi Device » (Appareil DTS Play-Fi)	2. Agregue "DTS Play-Fi Device" (Dispositivo Play-Fi de DTS)	2. Fügen Sie „DTS Play-Fi Device“ (DTS Play-Fi-Gerät) hinzu	2. Aggiungere "DTS Play-Fi Device" (Dispositivo DTS Play-Fi).	2. Adicione "DTS Play-Fi Device" (Dispositivo DTS Play-Fi).	2. 添加"DTS Play-Fi 装置"
3. Follow the instructions on your mobile device.	3. Suivez les instructions sur votre appareil mobile.	3. Siga las instrucciones que aparecen en su dispositivo móvil.	3. Folgen Sie den Anweisungen auf Ihrem Mobilgerät.	3. Seguire le istruzioni sul dispositivo mobile.	3. Siga as instruções exibidas no dispositivo móvel.	3. 遵循移动装置上的说明进行操作。

HOW TO USE CONNECT



You'll need Spotify Premium to use Connect, see details overleaf.

1. Add your new device to the same wifi network as your phone, tablet or PC (see product user instructions for details).
2. Open the Spotify app on your phone, tablet or PC, and play any song.
3. If you're using the app on a phone - tap the song image in the bottom left of the screen. For tablet and PC move to step 4.
4. Tap the Connect icon 
5. Pick your device from the list. If you can't see it, just check it's connected to the same wifi network as your phone, tablet or PC. All done! Happy listening.

Licenses

The Spotify Software is subject to third party licenses found here:
www.spotify.com/connect/third-party-licenses.

CONNECTIONS - 3.5MM AUXILIARY - INPUT

CONNEXIONS - ENTRÉE - AUXILIAIRE 3,5MM • CONEXIONES - 3.5 MM AUXILIAR - ENTRADA • ANSCHLÜSSE - 3,5-MM-AUX - EINGANG • CONNESSIONI - INGRESSO AUSILIARIO DA 3,5 MM • CONEXÕES - AUXILIAR DE 3,5 MM - ENTRADA • 连接 - 3.5MM 辅助电缆 - 输入

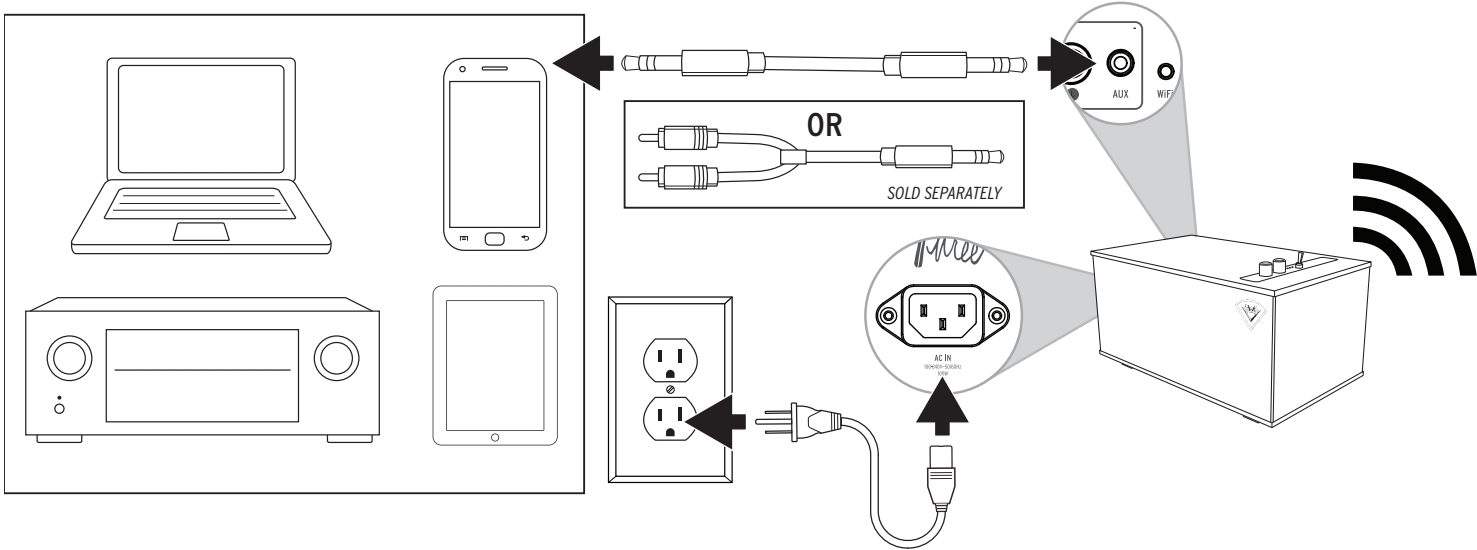

CONNECTIONS - ANALOG RCA - INPUT

CONNEXIONS - ENTRÉE - RCA ANALOGIQUE • CONEXIONES - RCA ANALÓGICA - ENTRADA • ANSCHLÜSSE- ANALOG RCA - EINGANG • CONNESSIONI - INGRESSO ANALOGICO RCA • CONEXÕES - ENTRADA RCA ANALÓGICA • 连接 - 模拟 RCA - 输入

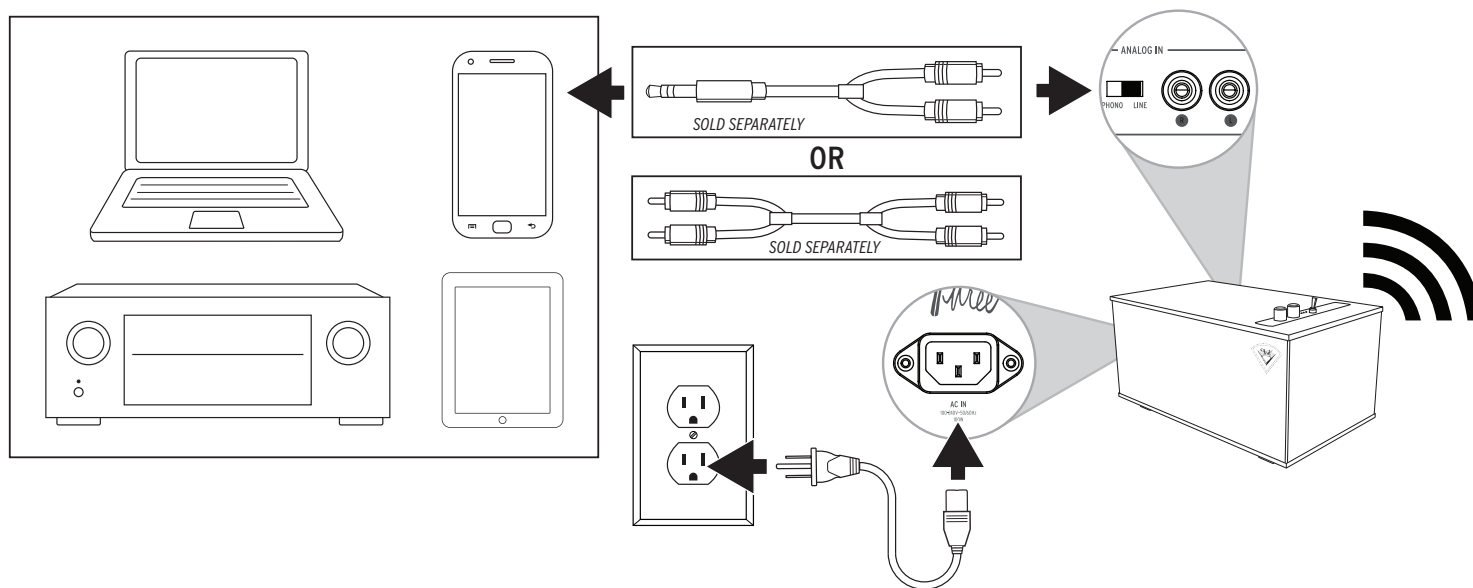

CONNECTIONS - TURNTABLE - INPUT

CONNEXIONS - PLATINES • CONEXIONES DEL TOCADISCOS • ANSCHLÜSSE - PLATTENSPIELER • CONNESSIONI - GIRADISCHI • CONEXÕES - TOCA-DISCOS • 连接 - 计算机

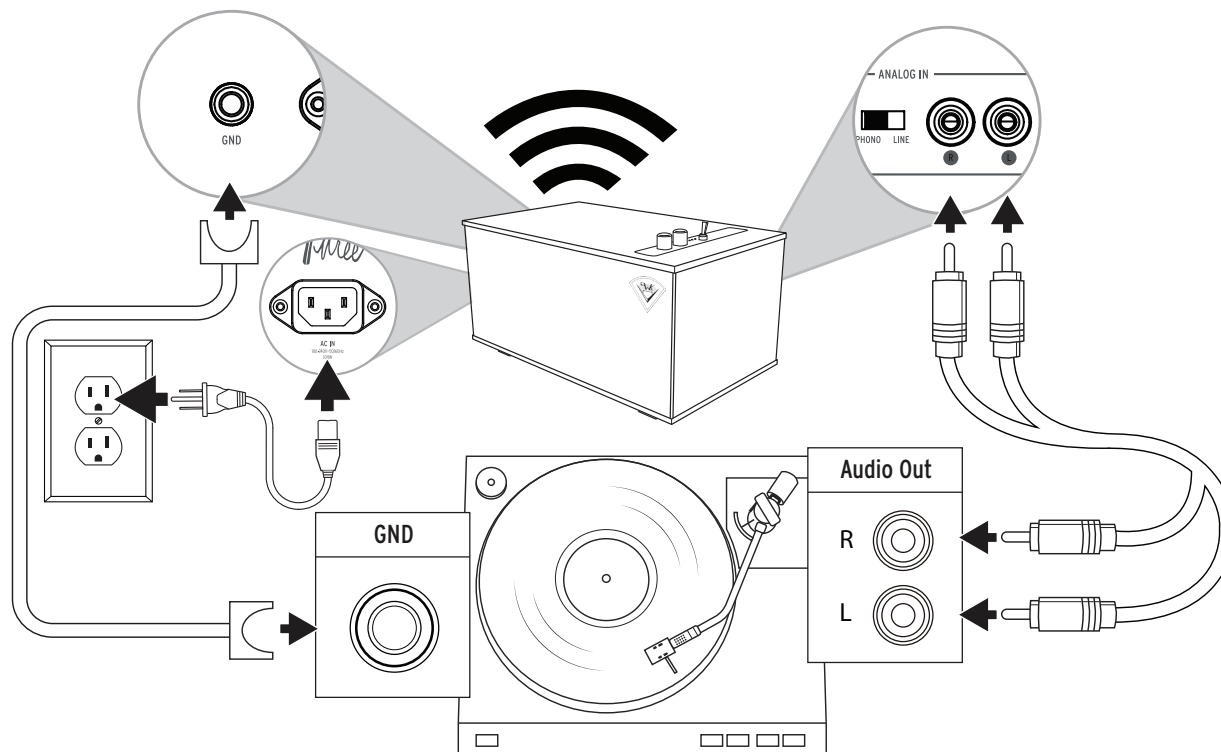

CONNECTIONS - USB AUDIO - INPUT

CONNEXIONS - ENTRÉE - AUDIO USB • CONEXIONES - AUDIO USB - ENTRADA • ANSCHLÜSSE- USB-AUDIO - EINGANG • CONNESSIONI - INGRESSO AUDIO USB • CONEXÕES - ENTRADA DE ÁUDIO USB • 连接 - USB 音频 - 输入

CAUTION: Install the dedicated driver software before connecting the computer to this unit via USB. For instructions about driver installation procedures, please access the support section of the web page <http://www.klipsch.com/heritage-wireless>

ATTENTION : Installez le logiciel du pilote dédié avant de connecter l'ordinateur à cet appareil par USB. Pour des instructions sur la procédure d'installation du pilote, veuillez consulter la section d'assistance de la page web <http://www.klipsch.com/heritage-wireless>

PRECAUCIÓN: Instale el software de controlador dedicado antes de conectar la computadora a esta unidad por USB. Hay instrucciones sobre el procedimiento de instalación del controlador en la sección de apoyo de la página web <http://www.klipsch.com/heritage-wireless>

VORSICHT: Spezielle Treibersoftware installieren, bevor Sie den Computer über USB an diese Einheit anschließen. Anweisungen zur Installation von Treibersoftware finden Sie im Support-Abschnitt der Website <http://www.klipsch.com/heritage-wireless>

ATTENZIONE. Installare l'apposito software (driver) prima di collegare il computer a questo apparecchio tramite USB. Per istruzioni per l'installazione del driver, accedere alla sezione di assistenza sulla pagina web <http://www.klipsch.com/heritage-wireless>

CUIDADO: Instale o software do driver dedicado antes de conectar o computador a esta unidade através de USB. Para obter instruções sobre os procedimentos de instalação do driver, acesse a seção de suporte da página da web <http://www.klipsch.com/heritage-wireless>

注意: 通过USB 将电脑连接到本机前, 请安装专用的驱动程序。关于驱动的安装程序的说明, 请访问网站 <http://www.klipsch.com/heritage-wireless> 的支持部分

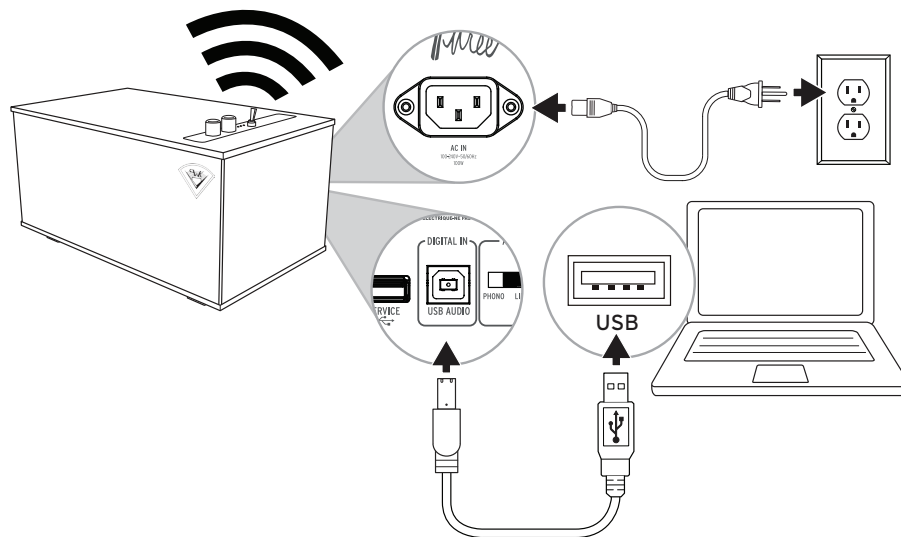

FACTORY RESET

RÉINITIALISATION • RESTABLECIMIENTO DE FÁBRICA • RÜCKSETZUNG AUF WERKSEINSTELLUNG • RIPRISTINO IMPOSTAZIONI DI FABBRICA • RESTABELECIMENTO DAS CONFIGURAÇÕES DE FÁBRICA • 恢复出厂设置

1 DISCONNECT POWER

DÉBRANCHER L'ALIMENTATION
DESCONECTAR ALIMENTACIÓN
VOM STROMNETZ TRENNEN
SCOLLEGARE IL CAVO DI ALIMENTAZIONE
DESCONECTE O CABO DE ALIMENTAÇÃO
切断电源

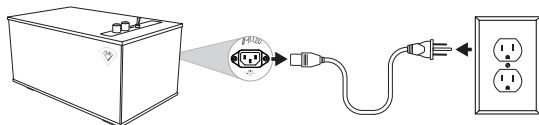

2 PRESS and HOLD while RE-CONNECTING POWER

APPLUYER ET MAINTENIR ENFORCE EN REBRANCHANT L'ALIMENTATION
OPRIMIR Y MANTENER OPRIMIDO MIENTRAS SE VUELVE A CONECTAR LA ALIMENTACIÓN
WIEDER ANSCHLIESSEN UND DABEI GEDRÜCKT HALTEN
TENERE PREMUTO MENTRE SI RICOLLEGA IL CAVO DI ALIMENTAZIONE
PRESSÃO E MANTENHA PRESSIONADO ENQUANTO RECONECTA O CABO DE ALIMENTAÇÃO
重新接通电源时，按下并保持

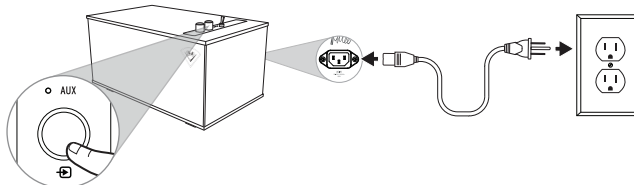

NOTE Factory Reset will clear the Bluetooth® pairing history

REMARQUE La réinitialisation aux réglages d'usine effacera l'historique d'association Bluetooth

NOTA El restablecimiento de fábrica borra el historial de vinculación de Bluetooth

HINWEIS Rücksetzung auf Werkseinstellungen löscht die gespeicherten Bluetooth-Kopplungen

NOTA Il ripristino delle impostazioni di fabbrica cancella la cronologia delle associazioni Bluetooth

OBSERVAÇÃO O restabelecimento das configurações de fábrica apagará o histórico de emparelhamento Bluetooth

注：出厂设置恢复将清除蓝牙配对历史

CARE AND CLEANING

ENTRETIEN ET NETTOYAGE • CUIDADO Y LIMPIEZA • PFLEGE UND REINIGUNG • CURA E PULIZIA • CUIDADOS E LIMPEZA • 保养与清洁

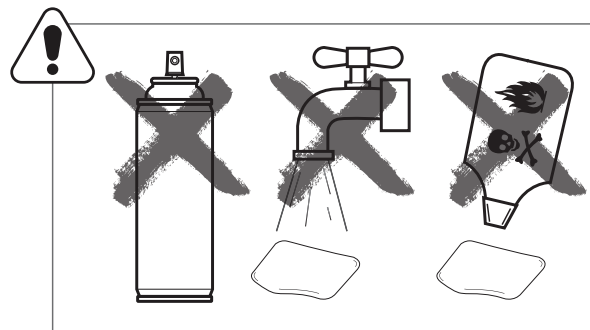
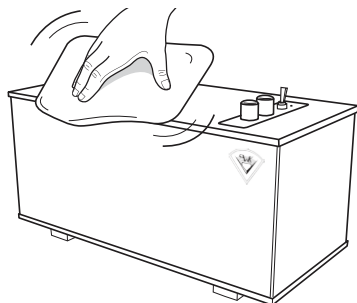

* USE MICROFIBER CLOTHS ONLY

*Utilisez des chiffons en microfibras seulement

*Use solamente paños de microfibra

*Nur Mikrofaserlätcher verwenden

*Usare solo panni in microfibra

*Use somente tecidos de microfibra

*仅限使用超细纤维布

Klipsch®

KEEPERS OF THE SOUND™

3502 WOODVIEW TRACE, INDIANAPOLIS, IN, USA

KLIPSCH.COM

©2016, Klipsch Group, Inc. Klipsch Group, Inc. is a wholly-owned subsidiary of Vox International Corporation. Klipsch and Keepers of the Sound are trademarks of Klipsch Group, Inc., registered in the United States and other countries. The *Bluetooth*® word mark is a registered trademark owned by Bluetooth SIG, Inc. and any use of such mark by Klipsch Group, Inc. is under license. DTS and Play-Fi are registered trademarks of DTS, Inc. For DTS patents, see <http://patents.dts.com>. Manufactured under license from DTS, Inc. DTS, Play-Fi, the Symbol and Play-Fi together in combination with the Symbol are trademarks of DTS, Inc. DTS and Play-Fi are registered trademarks of DTS, Inc. ©DTS, Inc. All Rights Reserved. SPOTIFY is a registered trademark of Spotify AB. Google Play is a trademark of Google Inc. Apple and the Apple logo are trademarks of Apple Inc., registered in the U.S. and other countries. App Store is a service mark of Apple Inc. All other trademarks are the property of their respective owners.